

### SPECIFICATIONS

- CONTACT RATING:** Dependent upon contact material.
- MECHANICAL LIFE:** 30,000 make-and-break cycles.
- CONTACT RESISTANCE:** 20mΩ max. initial @ 2-4VDC  
100mA for both silver and gold plated contacts.
- INSULATION RESISTANCE:** 1,000MΩ min.
- DIELECTRIC STRENGTH:** 1,000 V RMS@sea level.
- OPERATING TEMPERATURE:** -30°C to 85°C.

### MATERIALS

- CASE & BUSHING:** Class filled nylon 66, flame retardant, heat stabilized (UL94v-0).
- ACTUATOR:** Brass, chrome plated, internal O-ring seal. Standard for all actuators.
- SWITCH SUPPORT:** Brass, tin plated.
- CONTACT / TERMINALS:** Copper alloy with Silver or gold plated. (See Page 36)

## HOW TO ORDER

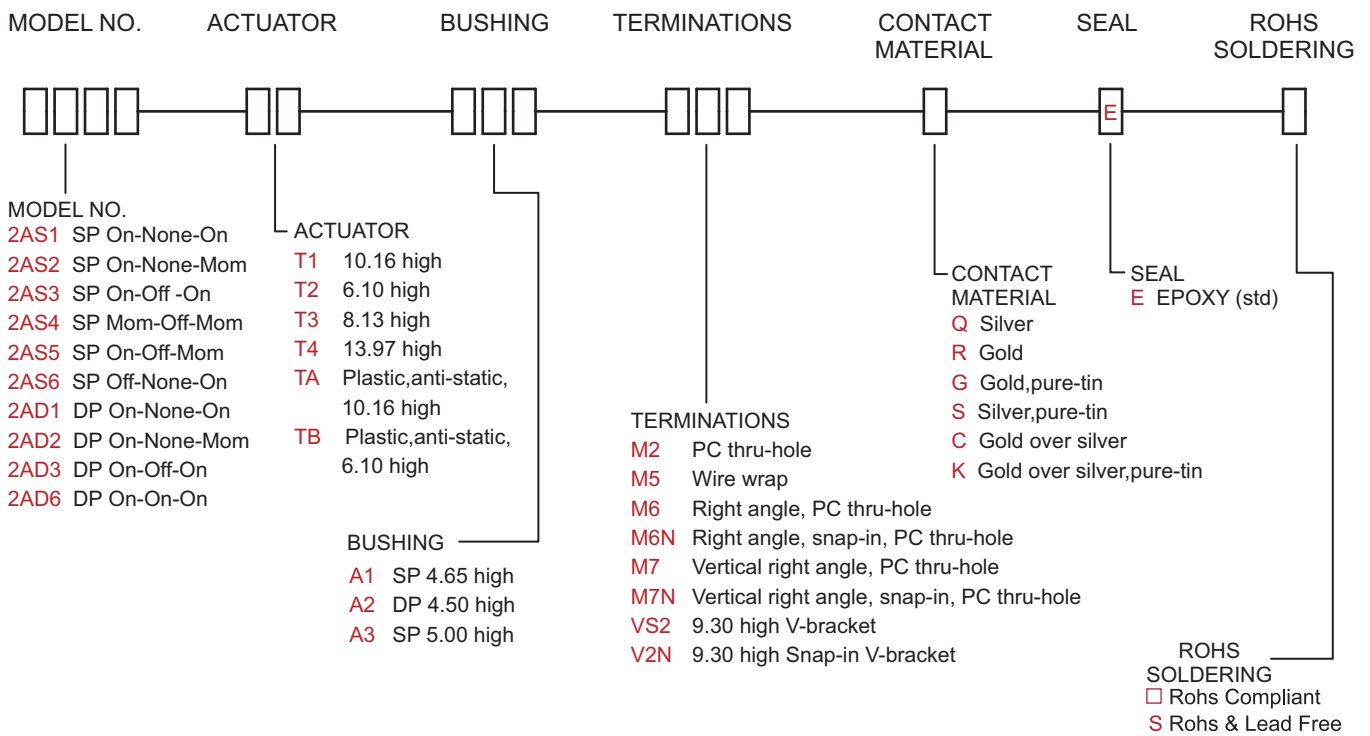

## SWITCH FUNCTION

NO. POLES	UL/CSA MODEL NO.	MODEL NO.	SWITCH FUNCTION			CONNECTED TERMINALS / SCHEMATIC		
			POS. 1	POS. 2	POS. 3	POS. 1	POS. 2	POS. 3
SP	Q22A11	2AS1	ON	NONE	ON	2-3	N/A	2-1
	Q22A12	2AS2	ON	NONE	MOM			
	Q22A13	2AS3	ON	OFF	ON		OPEN	
	Q22A14	2AS4	MOM	OFF	MOM			
	Q22A15	2AS5	ON	OFF	MOM			
	Q22A16	2AS6	OFF	NONE	ON	OPEN	N/A	3-1
DP	Q22A21	2AD1	ON	NONE	ON	2-3,5-6	N/A	2-1,5-4
	Q22A22	2AD2	ON	NONE	MOM			
	Q22A23	2AD3	ON	OFF	ON		OPEN	
	Q22A26	2AD6	ON	ON	ON			

MOM=MOMENTARY

## POLE OPTIONS



SPDT

Part No. Shown : 2AS1T1A1M2RE

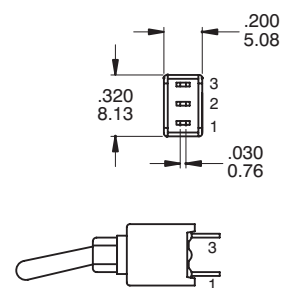
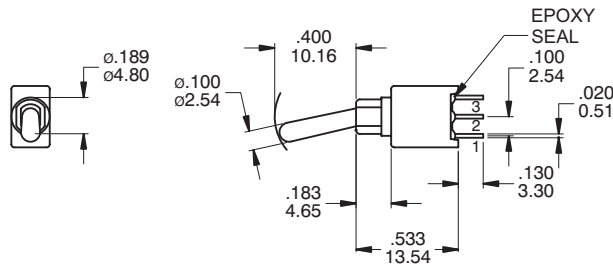

2AS6 Models : Omit 2nd terminal



DPDT

Part No. Shown : 2AD1T1A2M2RE

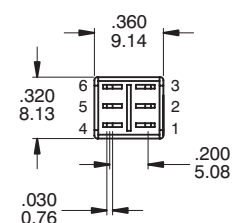
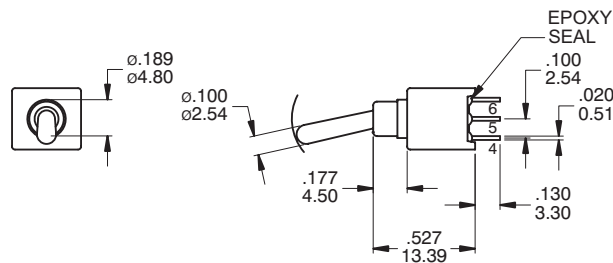

## TERMINATION OPTIONS

### M2

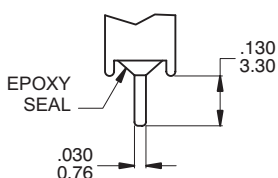

### P.C. MOUNTING

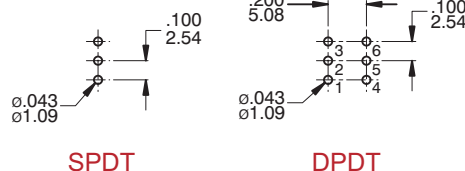

SPDT

DPDT

### OTHER TERMINATION OPTIONS

- M6 RIGHT ANGLE P.C. MOUNT
- M6N RIGHT ANGLE P.C. MOUNT
- SNAP-IN BRACKET
- M7 RIGHT ANGLE P.C. MOUNT
- VS2 VERTICAL BRACKET P.C. MOUNT

## ACTUATOR OPTIONS

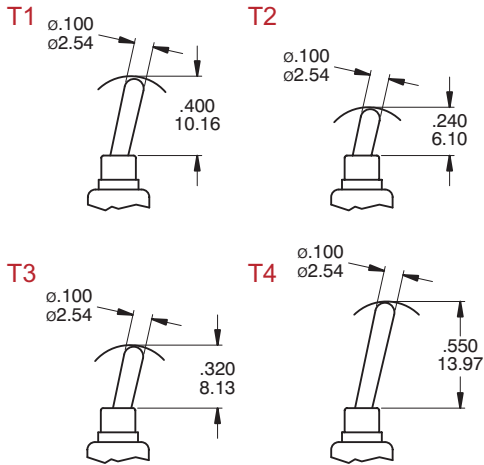

Actuator shown with A1 Bushing, sub .013 (0.34) for A3 Bushing.

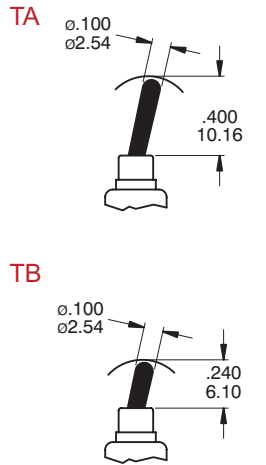

ESD PLASTIC ACTUATOR

## BUSHING OPTIONS

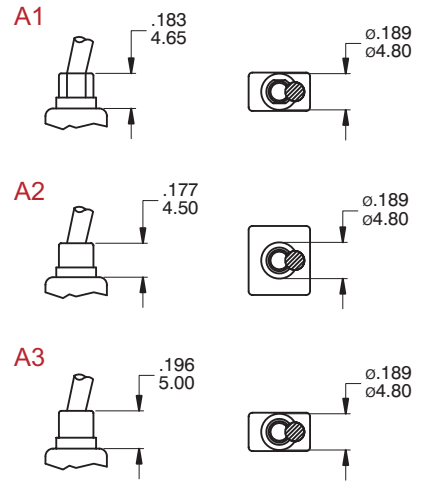

A1, A3 FOR SPDT / A2 FOR DPDT

### M6

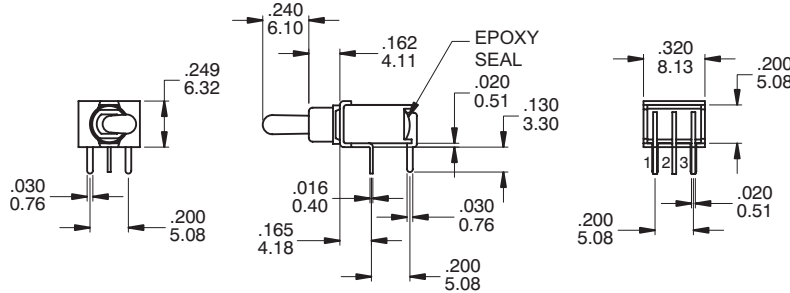
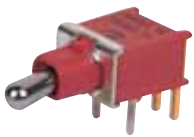

### SPDT

Part No. Shown : 2AS1T2A1M6RE

### P.C. MOUNTING

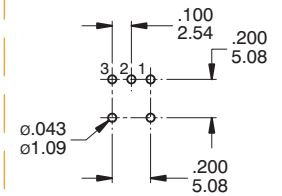

### M6

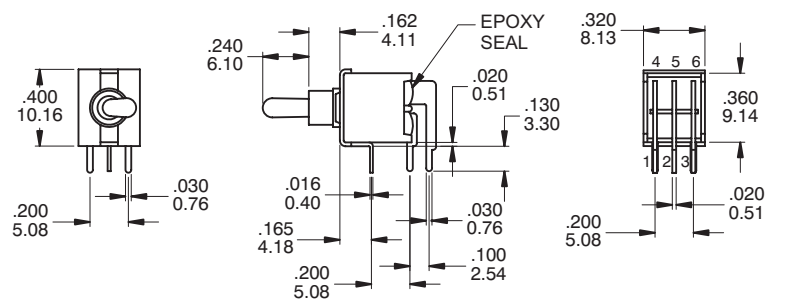
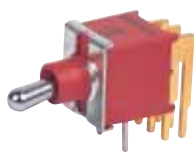

### DPDT

Part No. Shown : 2AD1T2A2M6RE

### P.C. MOUNTING

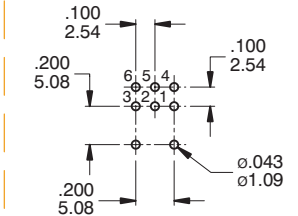

### M7

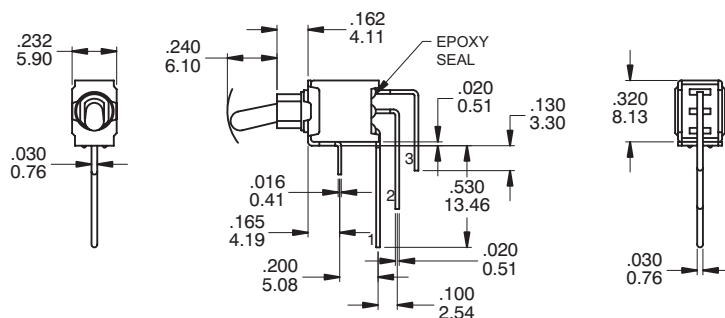
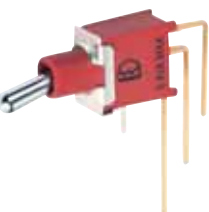

### SPDT

Part No. Shown : 2AS3T2A1M7RE

### P.C. MOUNTING

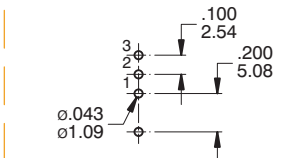

## M7

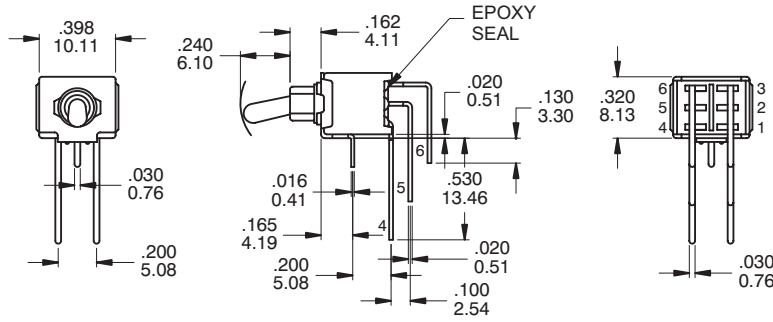
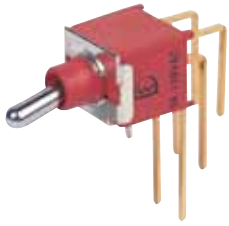

### P.C. MOUNTING

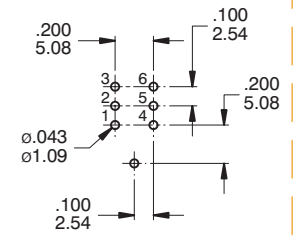

## DPDT

Part No. Shown : 2AD1T2A2M7RE

## VS2

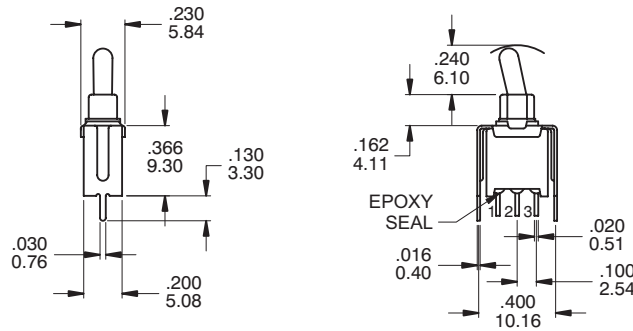

### P.C. MOUNTING

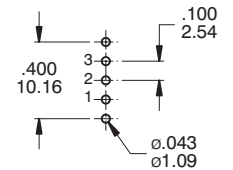

## SPDT

Part No. Shown : 2AS1T2A1VS2RE

## VS2

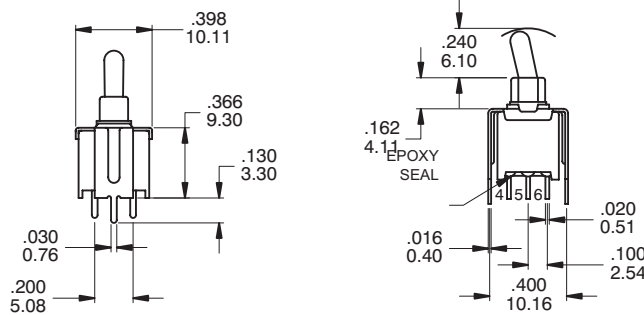

### P.C. MOUNTING

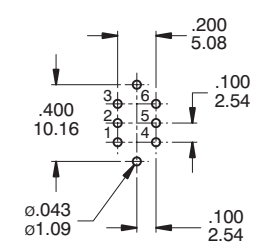

## DPDT

Part No. Shown : 2AD1T2A2VS2RE

## SNAP-IN TERMINATION OPTIONS

### M6N

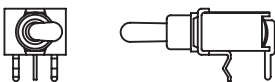

### M7N

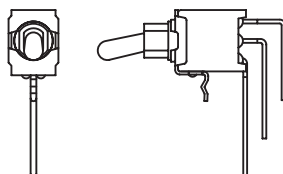

### V2N

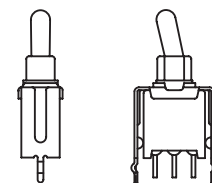

**CONTACT MATERIAL OPTIONS**

	CONTACT MATERIAL	TERMINAL PLATING	RATINGS
Q	Silver	Q = Gold flash over silver	3 Amps with resistant load @ 120VAC or 28VDC 1 Amps with resistant load @ 250VA
S		S = Gold flash over silver,pure - tin	
C	Gold over Silver	C = Gold over silver	
K		K = Gold over silver,pure - tin	
R	Gold	R = Gold	0.4 Volt - Amps ( VA ) max. @ 20V max. ( AC or DC )
G		G = Gold,pure - tin	



**IP 67**  
 ACCORDING TO  
 EN 60529:1991+A1:2001  
 IEC 60529:2001

**SOLDERING PROCESSES**

**MANUAL SOLDERING :** Use soldering iron of 30 watts, controlled st 350°C approximately 5 seconds while applying solder.

**WAVE SOLDERING :** Recommended Soldering Temperature : 260 ± 5°C  
 Duration of Solder Immersion : 5 ± 1 seconds  
 (PCB is 1.6mm in thickness)

**SOLDERING : Vapor phase**

