



SPECIFICATIONS

CONTACT RATING: AC 125V 6A, AC 250V 3A ,DC 28V 3A

MECHANICAL LIFE: 100,000 make-and-break cycles
DC 10V & 0.1mA.

CONTACT RESISTANCE: 10 mΩ max.

INSULATION RESISTANCE: 500V 500 MΩ min.

DIELECTRIC STRENGTH: 1,000 Vrms min.@sea level.

OPERATING TEMPERATURE: -40°C to 85°C.

MATERIALS

CASE: Diallyl phthalate (DAP) (UL94v-0).

ACTUATOR: Brass,chrome plated.

BUSHING: Brass,nickel plated.

HOUSING: Stainless Steel.

SWITCH SUPPORT: Brass,tin plated.

TERMINAL/CONTACT: Brass,with silver or gold plated.(See Page 23)



HOW TO ORDER

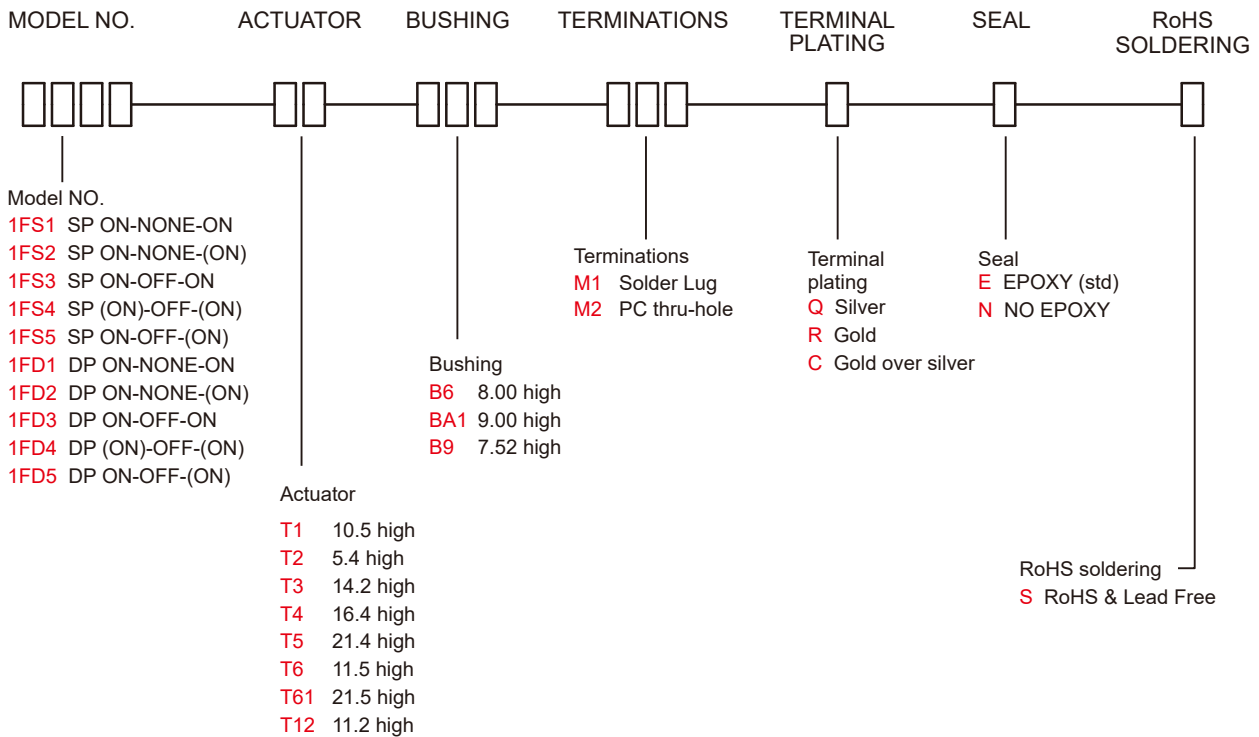

SWITCH FUNCTION

NO. POLES	MODEL NO.	SWITCH FUNCTION			CONNECTED TERMINALS / SCHEMATIC		
		POS.1	POS.2	POS.3	POS.1	POS.2	POS.3
SP	1FS1	ON	NONE	ON		N/A	2-1
	1FS2	ON	NONE	(ON)			
	1FS3	ON	OFF	ON			
	1FS4	(ON)	OFF	(ON)			
	1FS5	ON	OFF	(ON)			
DP	1FD1	ON	NONE	ON		N/A	2-1,5-4
	1FD2	ON	NONE	(ON)			
	1FD3	ON	OFF	ON			
	1FD4	(ON)	OFF	(ON)			
	1FD5	ON	OFF	(ON)			

()=MOMENTARY

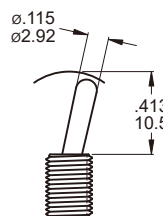
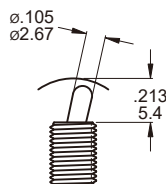
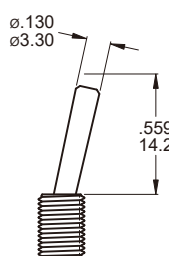
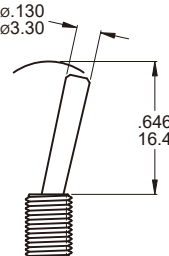
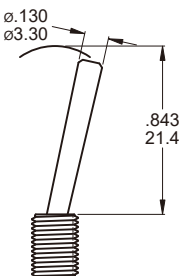
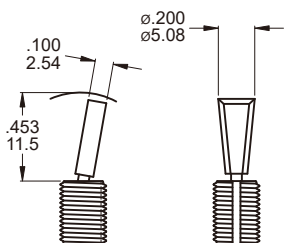
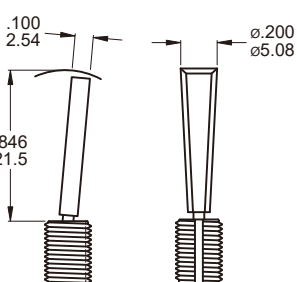
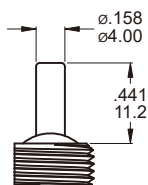
ACTUATOR OPTIONS
T1 STD

T2

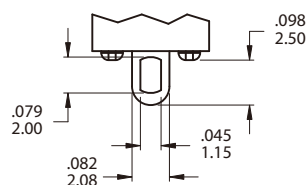
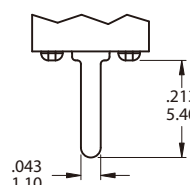
T3

T4

T5

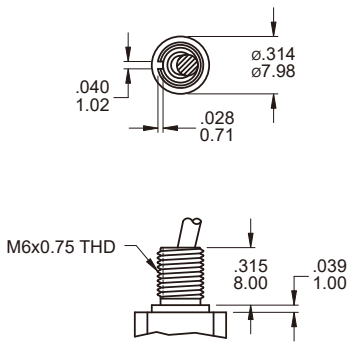
T6 FLATTED WITH ANTIROTATION

T6-1

T12

 T12 use with BA1 bushing only
 *T12 actuator mechanical life 200,000 cycles

T6, T6-1 use with B6 bushing only

TERMINATION OPTIONS
M1 Solder lug

M2 PC Thru - hole

BUSHING OPTIONS

B6 HIGH TORQUE

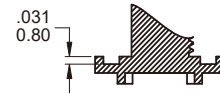
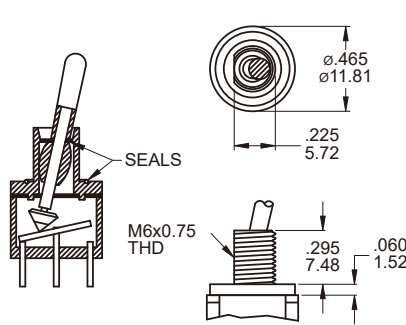

B9 SPLASH PROOF



CP-1TEB

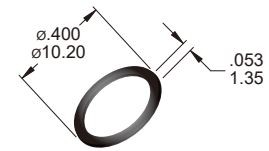

O-Ring
supplied with B9 bushing

BA1 SPLASH PROOF

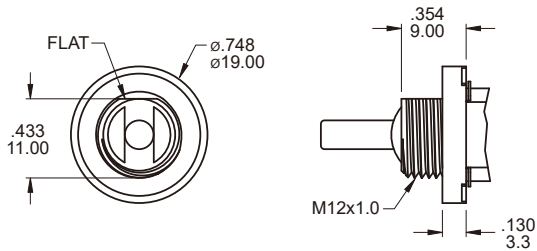

Use with T12 actuators only
BA1 Bear Strength from top of actuator
up to 10kg aside up to 15kg

POLE OPTIONS

SPDT

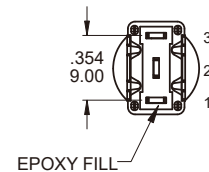
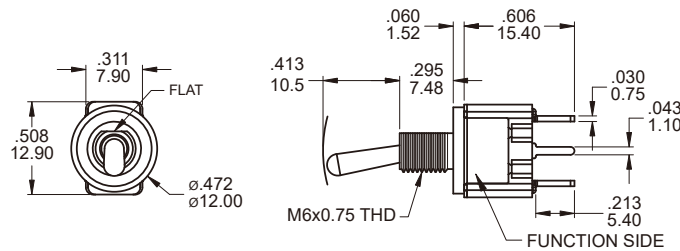

Part No. Shown : 1FS1T1B9M2RES

DPDT

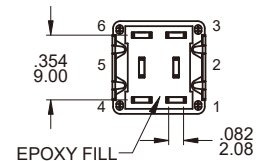
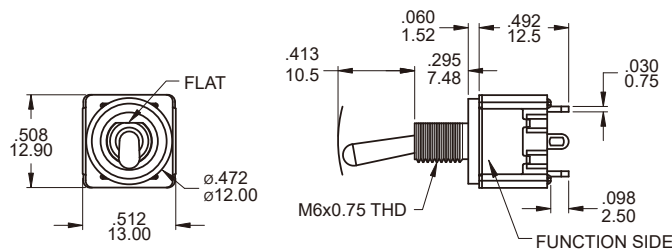

Part No. Shown : 1FD1T1B9M1QES

SPDT

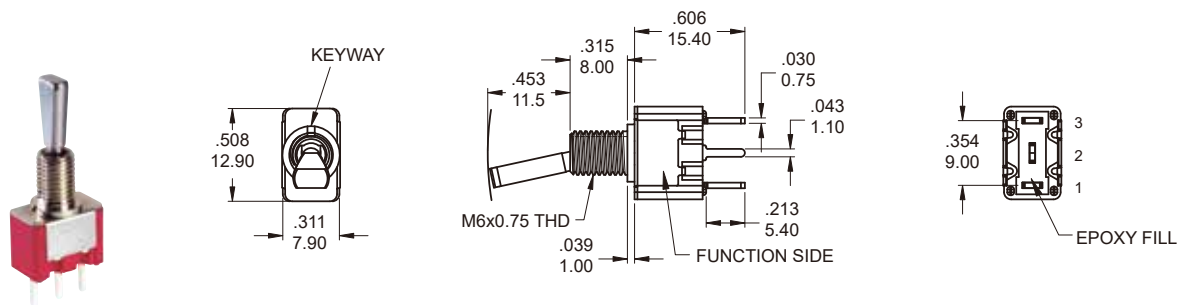

Part No. Shown : 1FS3T6B6M2QES

DPDT

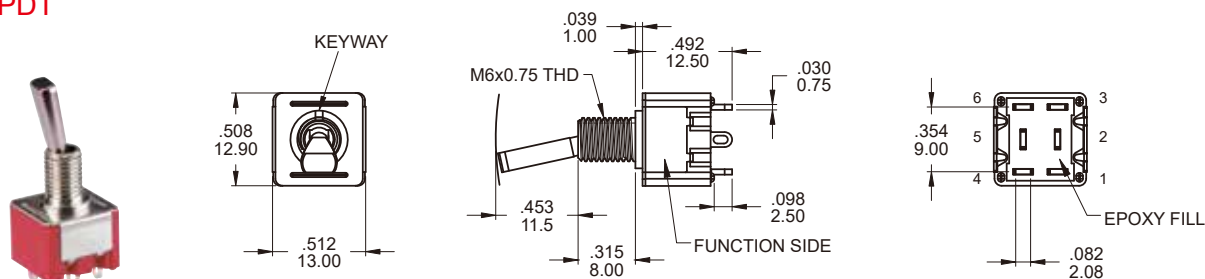

Part No. Shown : 1FD1T6B6M1QES

SPDT

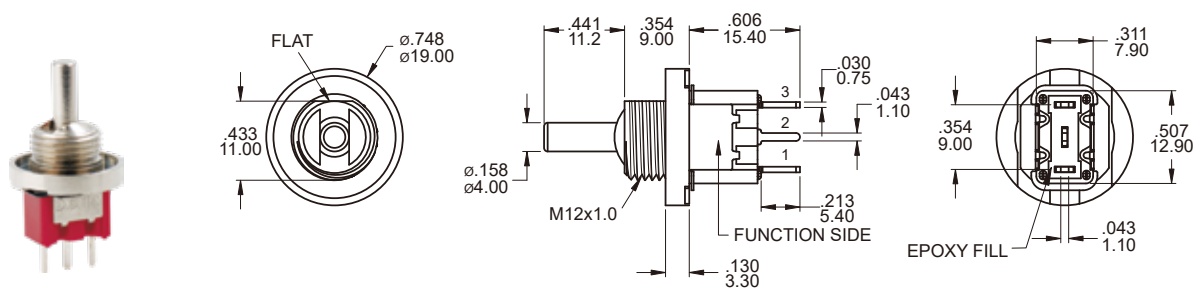

Part No. Shown : 1FS3T12BA1M2QES

SPDT

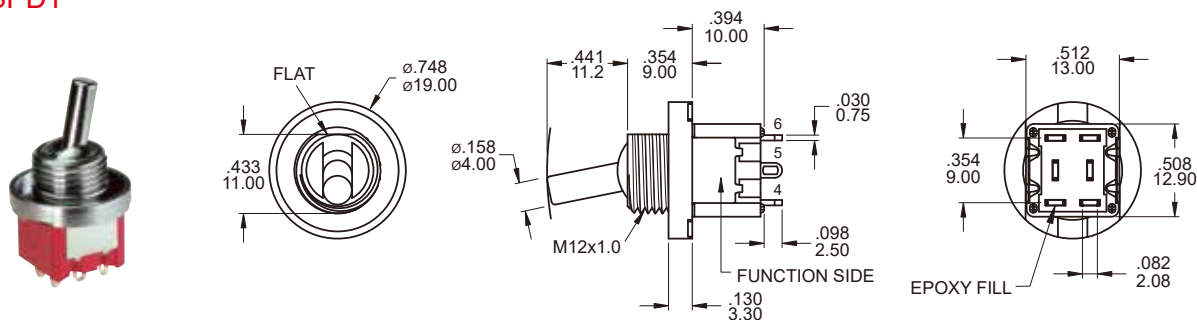

Part No. Shown : 1FD1T12BA1M1QES

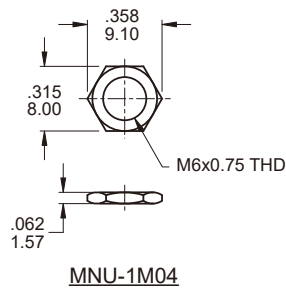
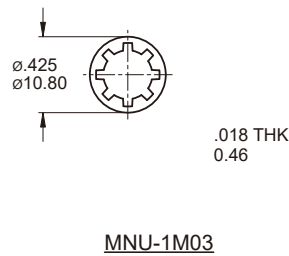
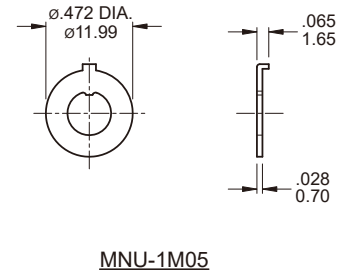
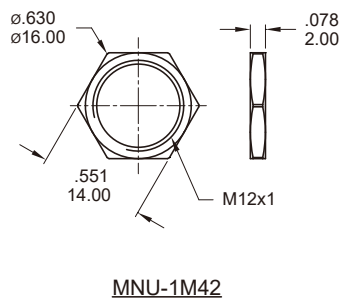
HARDWARE
M6x0.75 NUT

LOCKWASHER

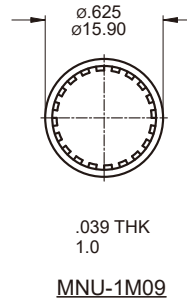
LOCKING RING

M12x1 NUT

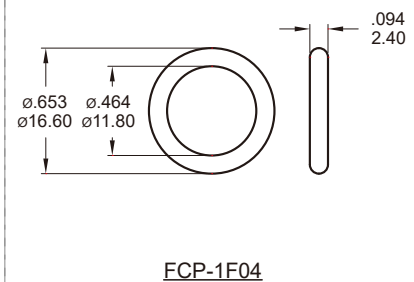
Supplied standard with BA1 bushing

LOCKWASHER

Supplied standard with BA1 bushing

O-RING

Supplied standard with BA1 bushing

CONTACT MATERIAL OPTIONS

	CONTACT PLATING	TERMINAL PLATING	RATINGS
Q	Silver	Silver	6 Amps with resistant load @ 125VAC
C	Gold over Silver	Gold over silver	3 Amps with resistant load @ 250VAC or 28VDC
R	Gold	Gold	0.4 Volt - Amps (VA) max. @ 20V max. (AC or DC)

SOLDERING PROCESSES

MANUAL SOLDERING : Use soldering iron of 30 watts, controlled at 350°C approximately 5 seconds while applying solder.

WAVE SOLDERING: Recommended Soldering Temperature: 270 ± 5°C

Duration of Solder Immersion: Max 5 sec. (PCB is 1.6mm in thickness)