

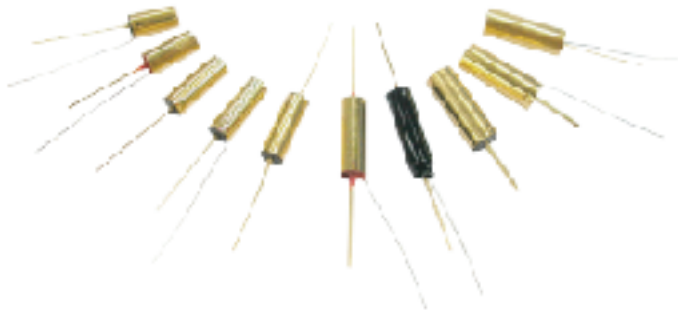

Tilt Switch Ball-Rolling Switch AT Series



SPECIFICATION

- Electrical Rating : 1~50mA/1.5~24VDC
- Electrical Life: >100,000 Cycles
- Contact Resistance: 300mΩ
- Solder Temperature: 250°C 3 Seconds
- Ambient Temperature: 0°C~100°C

MATERIAL

- Canister: Copper Gold Plated
- Electrode: Copper Gold Plated
- Rolling Ball: Stainless Steel Gold Plated
- Insulated Piece: Nylon 46(94V-0)

AT407 (Gold Shell Coating)

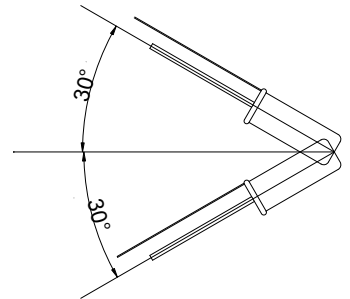
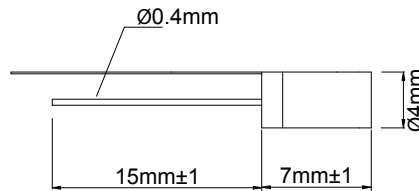

AT409

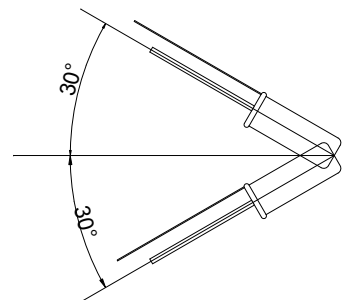
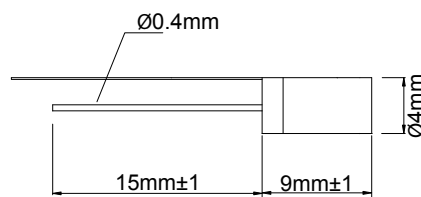

AT411

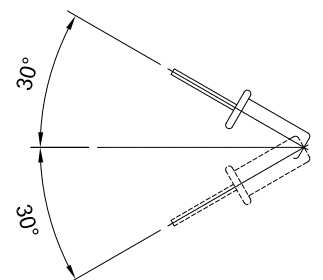
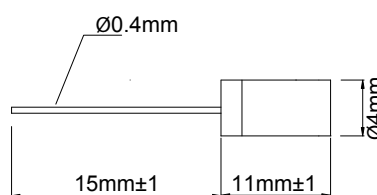



Tilt Switch Ball Rolling Switch AT Series

AT411-2

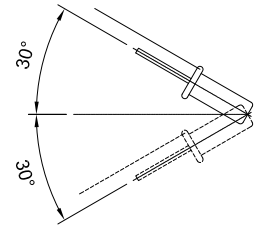
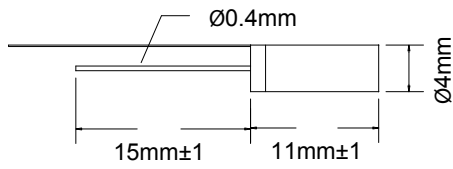

AT411-R2

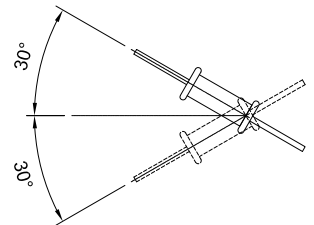
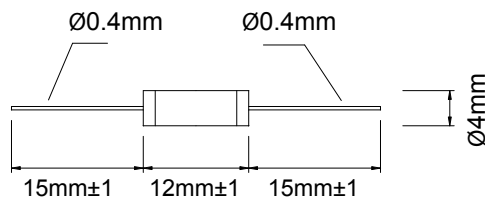

AT514

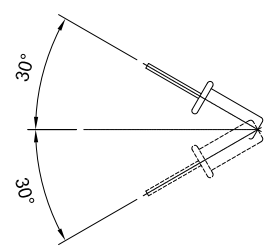
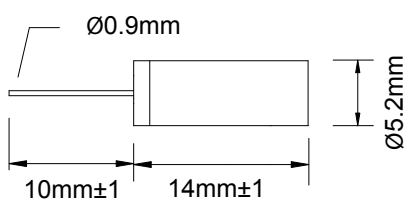

AT514-3

