



NON-DIRECTIONAL TILT SWITCH 507 SERIES

NEW PRODUCT INTRODUCTION

- 507 series is a new sensitive tilt switch/sensor. It is produced with environmental protection materials and meets RoHS compliance. The biggest feature is it could be operated at negative angle. Ultra small size helps to design in any device or P.C.B.

APPLICATION

- Toys like magic tools or game control.
- Auto Flashlight or remote control.
- More tilted application such as Alarm, Pedometer, etc.

SPECIFICATION

- Electrical Rating : 1~50 mA /1.5~30VDC
- Electrical Life: $>1 \times 10^5$ Cycles
- Contact Resistance : 300mOhm max (measured at 20°tilt)
- Solder Temperature: 350°C 3 Seconds (Solder bath)
260°C 5 Seconds (Solder iron)
- Ambient Temperature: -10°C~100°C

507

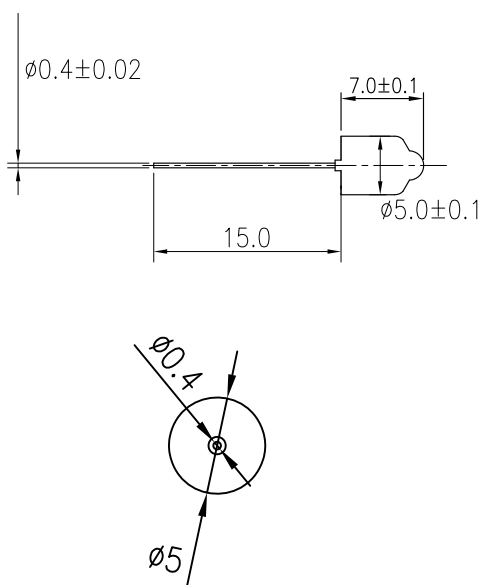
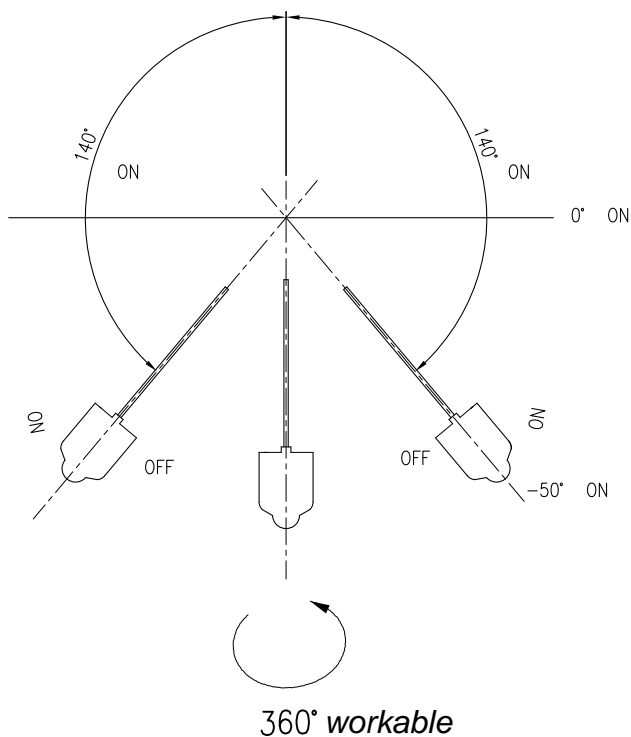

Unit : mm