

**TXJ Series** Miniature Micro Switch

**Features**

- ① Long Life Coil Spring Mechanism.
- ② Large Overtravel.
- ③ Integral Hinged Actuator.
- ④ Rock Wipe Contact Action.
- ⑤ Customer Designs.

**Applications**

Joystick, TV game, time recorder, air conditioner, food processor, juice maker, alarm, mixer, shredder machine, etc

**Specifications**

Rating	TXJ3 3A 125V/250VAC	Mechanical Life	5,000,000 cycles
	TXJ5 5A 125V/250VAC		
Contact Resistance	100m Ω Max.	Electrical Life	10,000 cycles
		Ambient Temper. Used	-25°C to 85°C
Insulation Resistance	>100M Ω DC500V	Ambient Humidity Used	<85% RH
Withstand Voltage	AC1000V 1min.	Operating Force	See Table
Soldering Temper.	260 5°C 3S		

**Table: Operating Force**

MODEL No.	OPERATING FORCE (gf)							
	10	60	80	110	160	200	300	
TXJ 3/5/6/10 - N- □□	—	28	35	45	80	100	140	
TXJ 3/5/6/10 -1N- □□	—	12	20	25	40	50	70	
TXJ 3/5/6/10 -2N- □□	—	25	32	40	70	85	130	
TXJ 3/5/6/10 -3N- □□	10	60	80	110	160	240	300	
TXJ 3/5/6/10 -4N- □□	—	28	35	45	80	100	140	
TXJ 3/5/6/10 -5N- □□	10	60	80	110	160	200	300	
TXJ 3/5/6/10 -6N- □□	—	25	35	45	70	85	125	
TXJ 3/5/6/10 -7N- □□	—	40	50	70	100	130	200	
TXJ 3/5/6/10 -8N- □□	—	20	30	45	60	80	120	
TXJ 3/5/6/10 -9N- □□								

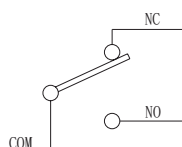
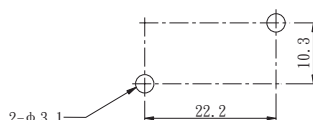
**SCHEMATIC**

**Mounting Hole Detail**

Mounting holes  
or M3 screw holes



Micro switch TXJ Series



TXJ3-N-□□

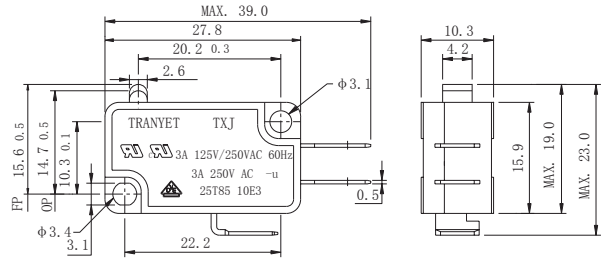
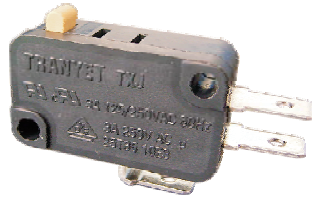

TXJ5-1N-□□

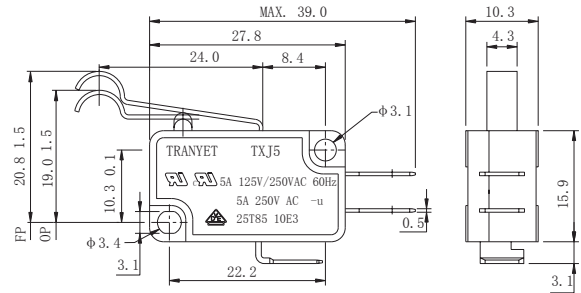

TXJ6-2N-□□

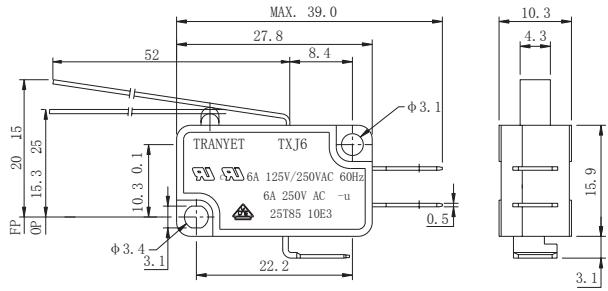
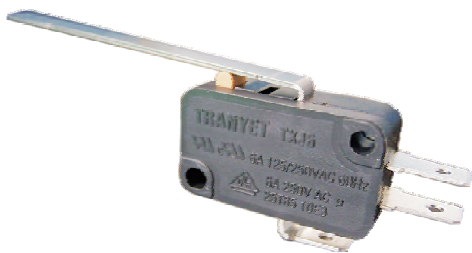

TXJ10A-3N-□□

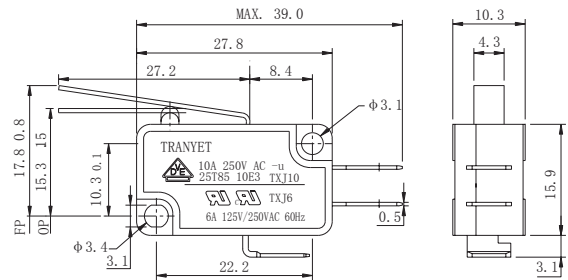

TXJ5-4N-□□

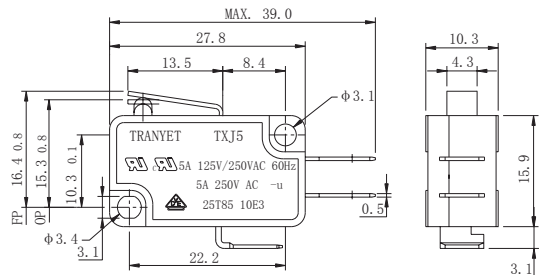
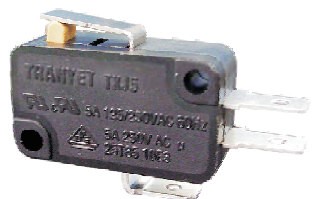

Micro switch TXJ Series



TXJ5-5N-□□

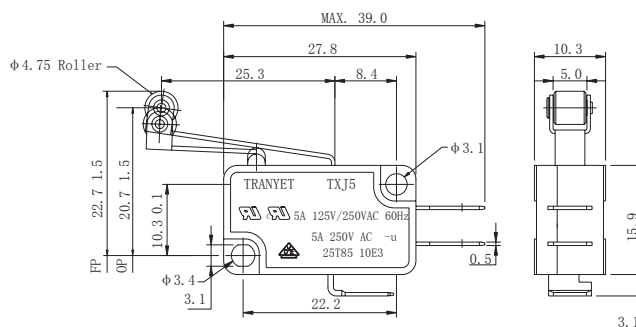

TXJ5-6N-□□

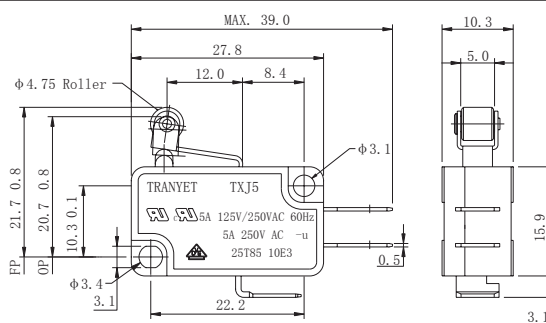
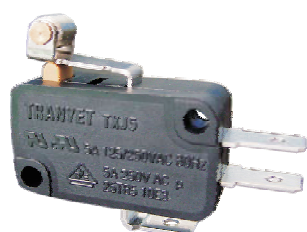

TXJ10A-7N-□□

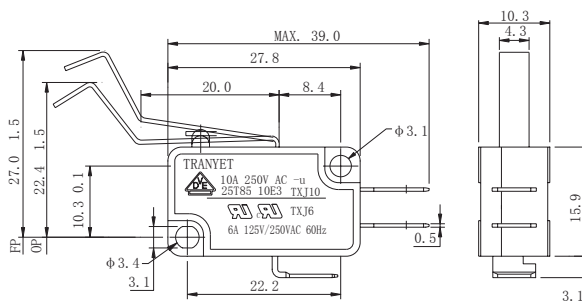
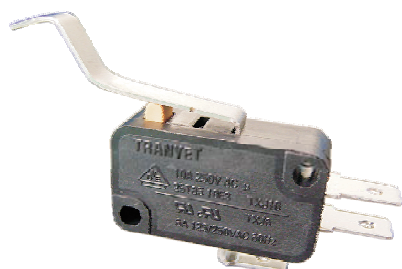

TXJ6-8N2-□□W

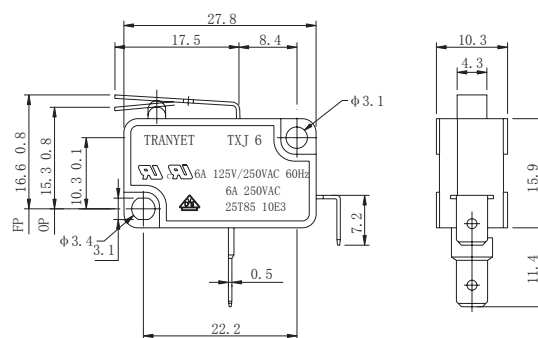

TXJ10A-9N2-□□R

